

Fleck 7000 Neutralizer Installation & Start-Up Guide

Thank you for purchasing a Clean Water System! With proper installation and a little routine maintenance your system will be providing treated water for many years.

Your new system comes with a printed Fleck Service manual, which along with this start-up guide will help guide you in the installation and start-up of your new system. The Fleck service manual covers other types of systems as well such as water softeners and filters, so there may be information in your Fleck service manual that does not pertain to your system. Please review this start-up guide entirely before beginning to install your system and follow the steps outlined for best results.

CALCITE MEDIA CONTAINS DUST. USE PAPER MASK AND VENTILATE TO AVOID BREATHING DUST.



2806-C Soquel Ave Santa Cruz CA 95062

For assistance call: 1-831-462-8500

Email us: office@cleanwaterstore.com

More information online: www.cleanwaterstore.com

Pre-Installation

1. Review your packing list and make sure you have received all the parts before beginning installation.
2. If you are going to be turning off the water to the house and you have an electric water heater, shut off the power to the water heater before beginning installation in case water heater is accidentally drained.
3. Pick a suitable location for your filter system on a dry level spot where it won't be exposed to freezing temperatures. A minimum of 20 PSI is required. Maximum pressure is 90 PSI.
4. Get all of your plumbing parts together before beginning installation. Installation typically takes 3 to 5 hours. However after installation the Calcite Neutralizer Filter must be allowed to run through a complete backwash and rinse cycle.
5. After the system is installed and running, your water may be discolored, or full of sediment or rust, particularly if this is older or corroded piping. Typically this clears up over a day or two.

Best Practices for Piping & Drain Installation

1. See typical installation (see Fig 2). The neutralizer filter is installed after the pressure tank.
2. Make sure to follow to connect the in pipe to the Fleck 7000 inlet and the outlet to the outlet (see Fig 2). As you face the Fleck 7000 control from the front, the water enters on the right and exits on the left. From the back (see Fig 2) the water enters on the left. The inlet and outlet are attached to the bypass valve which is marked with arrows as well.
3. Make sure there is a working gate or ball valve before the Fleck 7000 Neutralizer filter and also one after as shown in the diagram Fig 2. The pressure gauges are optional and perhaps not necessary but a hose bib (which is a faucet that you can attach a garden hose to) is strongly recommended after the neutralizer filter before the second ball valve. This makes it easy to rinse your new neutralizer filter on start-up and gives you a place to test the water before it enters your household plumbing. It also makes it much easier to perform the maintenance which involves adding more calcite media in the future, which must be done once a year for the typical residential calcite neutralizer.
4. If you will be using copper piping, do not sweat the copper pipe directly on to the Fleck 7000 control valve. Avoid heating up the Fleck 7000 control valve plastic with the torch.
5. If have copper pipe before the alcite neutralizer and it is too difficult to change it, you may still experience some copper staining of fixtures and have a copper residual in the water, because of

course this section of pipe will still have acidic water flowing through it. We recommend PEX or PVC pipe up to the neutralizer and then copper after it, if you have copper plumbing.

6. You do not need unions to install your Fleck 7000 control. If you need to remove it, the Fleck 7000 has quick-release couplings that make it easy to put the calcite neutralizer filter on by-pass and remove the filter system from the piping.
7. The drain line tubing (not supplied) is connected to a drain from the drain outlet using flexible ½" ID tubing. Note that the drain can run up above the Fleck 7000 control and into a drain, it does not have to drain down, as the filter backwashes under line pressure from your well pump. Most plumbing codes require an air-gap connection, so that if your sewer or septic tank backs up, it cannot cross connect with the drain tubing.

How Your Neutralizer Works

See Fig 1. In your neutralizer the water enters the top of the tank (red arrows) and flows down through the media and up the distributor tube (blue arrows). The downflow type neutralizer removes sediment and can be backwashed, which cleans and re-classifies the calcite, preventing channeling. During backwash, the water flow is reversed and water flows down the distributor tube and up through the media, lifting and expanding the calcite media. During the backwash the calcite is cleaned by the action of the water flowing through it.

Fig 1 - Calcite Neutralizer Filter Tank Water Flow

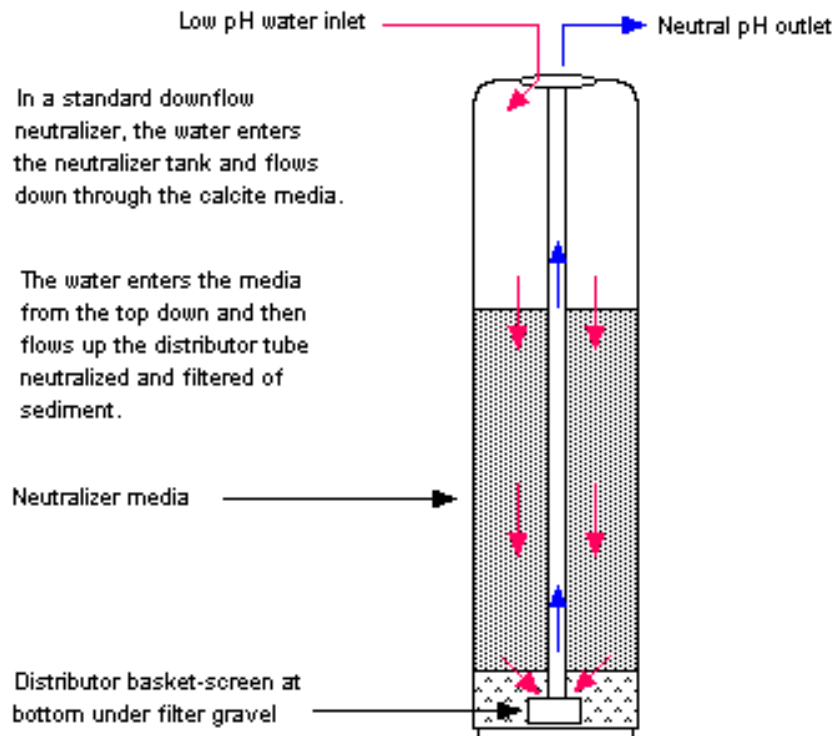
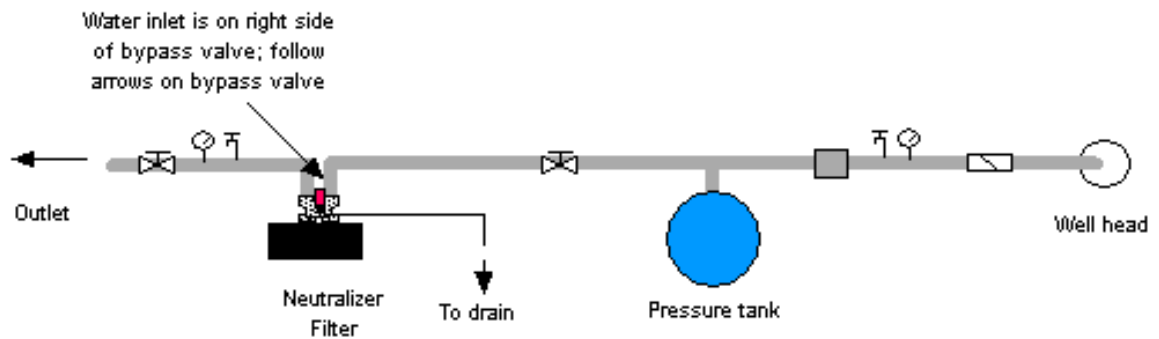
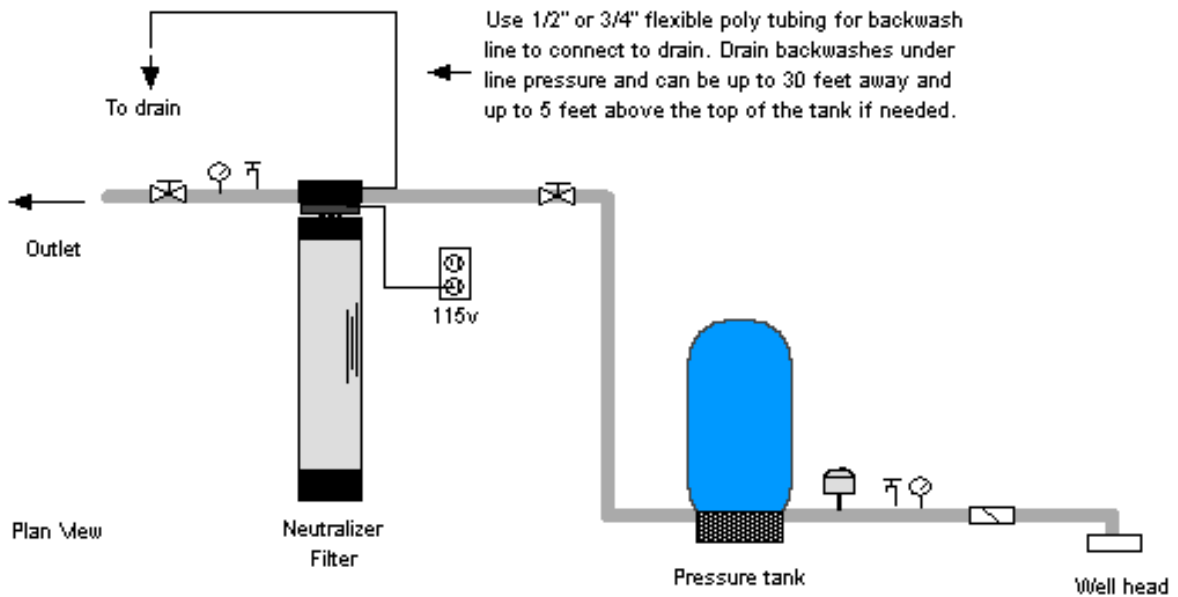







Fig 2 - Typical Neutralizer Fleck 7000 piping installation with ball valve and hose bib after the filter



Key

-  Optional Gate or ball valve
-  Optional Pressure gauge
-  Optional Hose bib
-  Water piping
-  Check valve
-  Pressure switch

Notes: follow inlet and outlet arrows on filter for proper installation. Connect 1/2" flexible tubing from backwashing control valve to a drain. If the distance to the drain is more than 20 feet use 3/4" or 1" tubing. Follow all local plumbing and electrical codes.

If you install a hose bib, pressure gauge and gate or ball valve after the neutralizer as shown, it will make it easier to service and test the water at a later date.

Assembly and Installation Instructions

1. Unscrew by hand the entire Fleck 7000 control valve from top of tank if it was shipped screwed on. Place distributor tube in tank if not already inside tank. If not already done, make sure blue cap is on top of distributor tube, or wrap the top of distributor tube with electrical or duct tape. You do not want gravel or calcite to go down the distributor tube.
2. See Fig 2. Add filter gravel supplied first, using the funnel sent with the Neutralizer filter.
3. Next add calcite or calcite-blend media. If you are using a blend of Calcite and Corosex make sure to read page 10 for more information on using and adding blends.
4. Remove cap or tape from top of distributor tube. Be careful not to pull up distributor tube when removing cap or tape.
5. If possible at this point, fill tank completely with water. This will allow the neutralizer media to settle and eliminate the need of “purging” the air out of the tank later.
6. Add a small amount of vegetable cooking oil to the tank threads and screw on Fleck 7000 control valve carefully. Alternatively you can use silicone grease, but do not use pipe-joint compound, Teflon tape, or Vaseline or other petroleum greases to lubricate tank threads.
7. See how the Fleck by-pass is connected. Note that Items 2 in Fig 5 below are the pipe connectors and the other end is what gets attached to the control valve. Items 3 are the red clips that hold the pipe connectors to the by-pass valve. Your Fleck 7000 is usually shipped in the by-pass position.

Fig 2

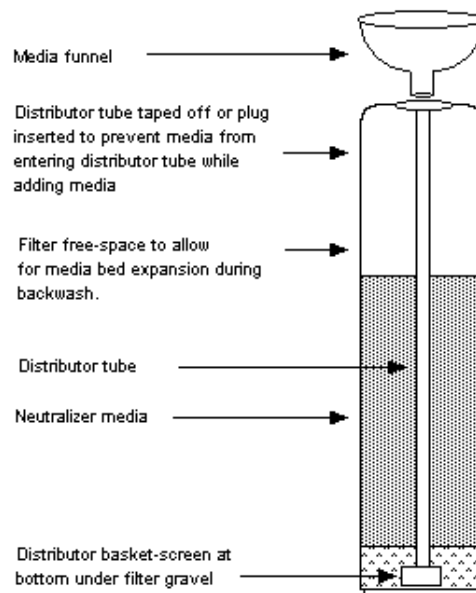
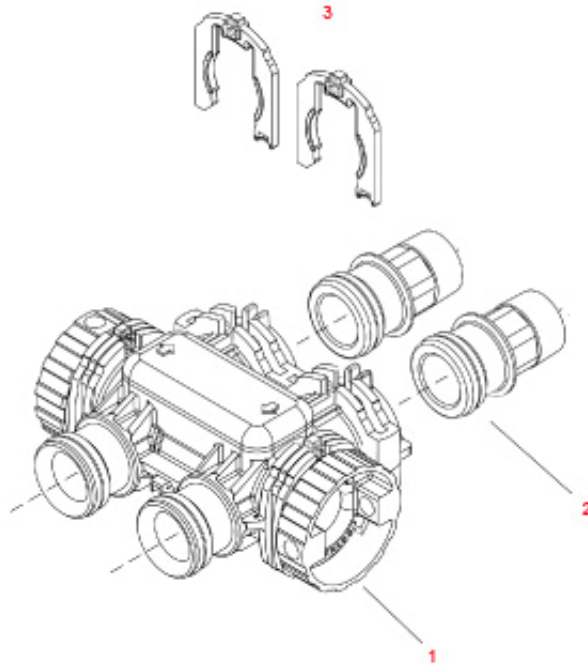

Fig 3 Fleck 7000 By-Pass and Pipe Connectors



8. See Fig 3. Lubricate the by-pass valve o-rings with some vegetable oil or silicone grease and connect the bypass assembly to the Fleck 7000 control by sliding the bypass valve firmly into the body of the Fleck 7000. Once bypass is in far enough, you will be able to insert the red connector clips.
9. Next lubricate the end-connectors (#2 in Fig 3) with some silicone grease or vegetable cooking oil and insert them into the bypass valve and then insert the red clips (#3).
10. Note that the Fleck 7000 is usually shipped in the bypass position. There is a bypass valve knob on both the inlet and the outlet (Fig 3 #1). You can easily tell if it is in bypass because the two holes on the bypass knob will be in the vertical position. If the valve is in the Service position (by which is the filtering position or 'in service' position) the holes will be in the horizontal position. Make sure both sides are in the by-pass position.
11. Do NOT remove the red clips in order to put the bypass valve in either bypass or service, it is not necessary nor desired to remove the red clips on the bypass valve hand knobs (see Fig 3 item 1, which are the knobs you will turn to move the bypass valves).

12. Now install your water pipes to the Fleck 7000 bypass end connectors. Make sure inlet is installed to the 'In" pipe connector on the bypass valve and outlet is on the "Out" connector.
13. Connect some flexible tubing from the drain connection on the Fleck 7000 control valve to a suitable drain such as a septic tank or drain to a sewer. It is OK to run the drain line up and over the Fleck 7000 Neutralizer filter up to 4 feet above the top of the tank. If the drain line will be more than 20 feet, use larger diameter tubing such as ¾" or 1". Note that it is desirable to be able to run the drain line into a bucket in order to test the backwash flow rate in the future. This is why hard piping the drain line is discouraged, however, if you do use hard PVC piping for the drain line, and you are able to remove the hard PVC drain piping and attach flexible tubing should you ever desire for testing purposes, it is OK to use rigid PVC pipe for the drain. Make sure the drain tubing is firmly clamped to the barbed fitting with a hose clamp to prevent leaks.
14. For the 2.5 cubic foot systems only: these larger tank systems have an external stainless steel flow control that comes with the system. This must be installed. If you have a 1.0 or 1.5 cubic foot system, the flow control is internal and there is no external drain flow control.
15. Plug in your Fleck 7000 control valve to an outlet. Your Neutralizer 7000 control valve is already pre-programmed. All you need to do is to set the time of day, and then set the number of days the Neutralizer filter will run before it backwashes and regenerates automatically. The default number of days between back wash is seven.
16. Set the time of day by pressing the up or down arrows until it is the current time of day.
17. Hold down the up arrow and down arrow at the same time for 5 seconds. Set the time of the night that you want the Neutralizer filter to backwash. The default time is 2:00 am. Adjust the time by pushing the up or down arrow if you want.
18. Press the Extra Cycle button once. Now set the number of days between backwashes, the default is 7 days. If your water is very clean (no sediment or iron) you can set the backwash frequency to as little as every 14 days but its best to leave it to backwash every 7 days.
19. Now press the Extra Cycle button once more. You are done programming!
20. Now you are ready to turn on the water. Turn on the water and leave the neutralizer on bypass and check for leaks. Leave the ball valve after the Neutralizer filter closed, so water is still off to the house, but connect a garden hose and open up the hose bib after the Neutralizer filter and allow the water to run. This will help to clear out any foreign material that may be in the pipes from the piping installation. If you do not have a valve installed after the Neutralizer filter and you do not have a hose bib, you will need to turn the water on inside the house to let the water run. Use a bathtub or laundry sink or other fixture that does not have an aerator screen.
21. Leave the water running out of the garden hose at a slow rate.
22. Press the Extra Cycle button for a second or two which will start a manual backwash.

23. Now you can slowly turn the bypass valve to the service position. You do NOT remove the red clips on the bypass knobs in order to turn the bypass valves from the bypass to the service position. First open the Inlet Side of the bypass valve. Second slowly open the Outlet Side of the bypass until it is in the full service position. The Fleck 7000 bypass valve knobs are a little stiff, so you can use a screw driver placed in the holes to turn the knobs. Make sure you are turning the bypass valve knobs in the correct direction which is clockwise as you face the bypass valve knobs.
24. There should be no calcite media coming out of the drain line, but the water will be milky or dirty looking. At this point the Neutralizer filter will be in a backwash cycle. The backwash takes 10 minutes. If the water slows down or stops during the first 10 minutes of backwash, press the Extra Cycle to move the Fleck 7000 control to the next cycle, the Rinse cycle. Then repeat the backwash and rinse after the rinse cycle is done, by pressing the Extra Cycle again. If you have high water pressure you may need to turn on the water slowly to the neutralizer at first to prevent some calcite fines from coming out the backwash. However it is normal for some small amount of fines to come out during the backwash, although you do not want to see a large amount of media coming out, which would mean you have very high water pressure, or the drain flow for the Fleck 7000 is missing.
25. If possible verify that the backwash flow is 5 gallons per minute, which is the recommended backwash flow rate for 1.0 and 1.5 cubic foot models. If you have a 2.5 cubic foot neutralizer it should be backwashing at 10 gallons per minute. You can easily run the drain hose to a bucket and using a watch verify the flow rate in gallons per minute. An adequate backwash is critical to properly clean the calcite media and prevent it from cementing together.
26. The next cycle is the Rinse cycle and this also runs for 10 minutes.
27. After the neutralizer has gone through the backwash and rinse, press the Extra Cycle button and repeat the backwash and rinse. This is the same procedure that needs to be done each time you add calcite media in the future, that is, the calcite media must be thoroughly backwashed and rinsed.
28. Refer to your Fleck 7000 service manual for more information about how your control valve is programmed if desired.

Maintaining Your Neutralizer 7000 Filter System

1. Check the pH before after the neutralizer. You want to have a pH of at least 7.0 after the neutralizer filter.

2. When the pH drops below 7 check the depth of the calcite media by shining a bright light through the tank. Your media should be about 2/3rds full. When the media level drops to ½ full, it is time to add more calcite or calcite blend media if you are using a blend.
3. For most residential applications add calcite media once or twice a year. Do not fill more than 3/4ths full, about 2/3rds full is best.

How to Add Calcite Media to the Fleck 7000 Neutralizer Filter

CALCITE MEDIA CONTAINS DUST. USE PAPER MASK OR VENTILATE TO AVOID BREATHING DUST.

1. Begin by putting neutralizer filter on bypass, or turning the water pressure off before the neutralizer.
2. Initiate a manual backwash cycle. Since it is on bypass, this will relieve the pressure inside the control valve so you safely unscrew the Media Fill Plug located on top of the neutralizer tank.
3. Unplug the control valve cord from the wall outlet.
4. Unscrew the media fill plug with a channel locks or pliers and using a tube or hose, siphon 2 to 3 gallons of water out of the filter tank.
5. If you don't siphon water out, when you add filter media, water will flow out the fill plug hole and flow onto the floor. If water on the floor is OK then you do not have to siphon water out first before pouring calcite media into top fill plug hole.
6. Add neutralizer filter media until the tank is 2/3rds full. Do not over-fill; be sure to leave at least 12" of free space above media to allow room for the media to expand during a backwash.
7. Put the top fill plug back in. You can lubricate the threads with some vegetable oil or silicone grease, but do not use Teflon tape or plumbing grease.
8. Plug back in the control valve and press the Extra Cycle button so the Fleck 7000 control is in a backwash cycle.
9. Slowly turn on the bypass valve slowly at first back to the service position (if it is in "service" this means it is in the proper position for filtering and neutralizing).
10. Allow the system to go through a complete backwash and rinse cycle. Repeat backwash cycle by starting another manual cycle, so the neutralizer is thoroughly backwashed and rinsed before putting it back into service.

When to Use Calcite Blends

If the water pH is less than 6.0, calcite alone may not be enough to bring the pH up to the desired pH range of 7.0 to 7.8. In this case a blend of Calcite and Corosex should be used. Calcite is a calcium media consisting of calcium carbonate and raises the pH slowly. Calcite will not raise the pH much over 7.2. Corosex is a natural mineral media consisting of magnesium oxide. It reacts much faster and raises the pH much higher than Calcite alone.

Corosex is almost never used alone as it will raise the pH too high and in some cases will over-correct and create a highly basic (high pH) condition. It can also cement together like concrete in the neutralizer tank if you add too much and there is not sufficient backwash.

So for most residential well applications a 90% calcite and 10% Corosex is best. However, in some cases a 80%/20% mix or even a 70%/30% is used. It is always better to start with a 90%/10% mix at first as this solves the majority of low pH problems in the range of 4.5 to 5.9.

For a pH of 5.0 to 6.9 use calcite alone.

For pH of 4.5 to 5.9 use a blend of Calcite and Corosex usually 90% calcite and 10% Corosex.

How to Mix and Use Calcite Blends

The Calcite and Corosex media is sold and shipped in separate boxes. It does not have to be completely blended together to use as it will mix during the backwash and rinse cycles. Still when you are adding the Calcite and Corosex it is better to blend it lightly in a 5 gallon bucket and then add it. Or you can add some calcite and then add some Corosex as you are filling the tank.

Calcite is shipped in 50 lb boxes and one box of Calcite is equal to 0.55 cu ft.

Corosex is shipped in 10 lb boxes and 1 box is equal to 0.13 cu ft.

50 lbs of Calcite = 0.55 cubic foot of media

50 lbs of Corosex = 0.66 cubic foot of media

Neutralizers 1.0 Cubic Foot: use 90lbs Calcite and 10 lbs Corosex

Your new 1.0 Cubic Foot Neutralizer Blend filter includes:

Calcite 100 lbs (2 50-lb boxes) 1.1 cu ft

Corosex 10 lbs (1 10 lb boxes) .13 cu ft

If you add all the media you receive you will have: 1.1 cu ft Calcite + .13 cu ft Corosex for a total of 1.23 cubic foot, not including the gravel. You do not want the tank to more than 2/3rds full, so generally we recommend you add a little less. You can deduct the amount of calcite by 10 lbs and add 90 lbs calcite and 10 lbs Corosex. However in the 1.0 cubic foot tanks it is not that critical and many of our customers over the years have added all the media they receive (100 lbs of Calcite and 10 lbs of Corosex) with good results. If your water pressure was very high and the water very cold (higher viscosity) then there is a small chance that if you used 1.23 cu ft of calcite blend media in a tank meant for 1.0 cubic foot, you might get a small amount of media washed out in the backwash.

Neutralizers 1.5 Cubic Foot: use 125 lbs Calcite and 15 lbs Corosex

Your new 1.5 Cubic Foot Neutralizer Blend filter includes:

Calcite 150 lbs (3 50-lb boxes) 1.65 cu ft

Corosex 20 lbs (2 10 lb boxes) .26 cu ft

If you add all the media you receive you will have: 1.65 cu ft Calcite + .26 cu ft Corosex for a total of 1.91 cubic foot, not including the gravel. You do not want the tank to more than 2/3rds full, so generally we recommend you add 1-1/2 boxes of Calcite (125 lbs) and 1-1/2 boxes of Corosex (15 lbs).

Neutralizers 2.5 Cubic Foot: use 225 lbs Calcite and 20 lbs Corosex

Your new 2.5 Cubic Foot Neutralizer Blend filter includes:

Calcite 200 lbs (4 50-lb boxes) 2.2 cu ft

Corosex 20 lbs (2 10 lb boxes) .26 cu ft

Add all the media you receive and you will have: 2.2 cu ft Calcite + 0.26 cu ft Corosex for a total of 2.46 cubic foot, not including the gravel.

Troubleshooting the Fleck 7000 Neutralizer Filter

One problem that may occur is if you do not have enough backwash flow rate to properly clean the Neutralizer filter. You can verify the backwash flow rate by running the drain line into a bucket and timing it when the Fleck 7000 is in Cycle 1 or backwash. A 1.0 or 1.5 cubic foot system should have 5 gallons per minute and a 2.5 cubic foot system should have 10 gallons per minute of backwash.

In some cases, the Fleck 7000 may not be programmed correctly. See the Fleck 7000 service manual for instructions on how to access the master programming. Your Fleck 7000 should be set for FLtr or Filter mode and have two cycles, backwash and rinse.

If your pH is not as high as you desire then you can always add more Corosex later usually in increments of 10 lbs each at a time.